



# VERMONT TIMBER WORKS

INCORPORATED

*Beautiful Heavy  
Timber and  
Glue Laminated  
Frames for  
Homes, Churches,  
Stores, Hotels  
and Commercial  
Buildings*



36 FAIRBANKS ROAD  
NO. SPRINGFIELD, VT 05150

(802) 886-1917

(FAX) 802-886-6188

[vermonttimberworks.com](http://vermonttimberworks.com)



## ABOUT VERMONT TIMBER WORKS

Vermont Timber Works Inc. manufactures high quality timber frames for homes and commercial buildings. We have been designing, cutting and assembling post and beam frames from the simple and rustic to the highly finished and elegant since 1987. We engineer our frames in-house, which gives us the ability design and build timber structures of remarkable complexity and span.

We use a variety of timber, including douglas fir, eastern white pine, native hemlock, oak, cedar and southern yellow pine. Our joinery is traditional with authentic mortise and tenons, dovetails and wooden pegs. Connections using steel gusset plates and bolts are popular for commercial work or when a look reminiscent of old mill buildings is desired. All of our frames are handcrafted to meet exact project requirements, and we enjoy working with our clients to make sure the details – from design to finish – are just right.

Please visit our web page at [vermonttimberworks.com](http://vermonttimberworks.com) to see many more photographs of our work, and to learn much more about timber framing. The site is extensive and has information on building design, wood species and finishes, the framing process, churches, barns, pavilions, houses, hotels and much more.

**COVER PHOTO:  
HAWTHORNE SUITES HOTEL LOBBY**

This beautiful timber frame is in Burlington, VT. It features a cathedral ceiling, central fireplace, curved braces and smooth western fir timbers with a clear urethane finish. It is one of our many frames that can be viewed by the public. Directions to this and more places to visit can be found by clicking on the “See Our Timber Frames” link on our home page: [www.vermonttimberworks.com](http://www.vermonttimberworks.com).





# TIMBER FRAMING

The bent is the building block of a timber frame home. As a cross section through the building, it supports the home and gives its shape. There are many types of bents, they can be modified to almost any style, and different bents can be used in the same building to form L's, additions, porches and sheds.



**THE TYPICAL BENT**

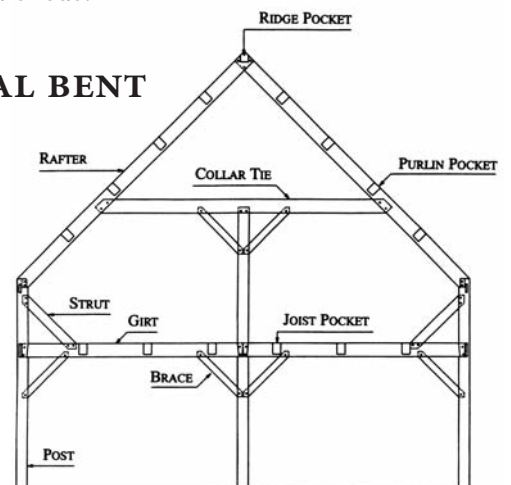

# THE TYPICAL BENTS

2-1/2  
STORY  
COLONIAL

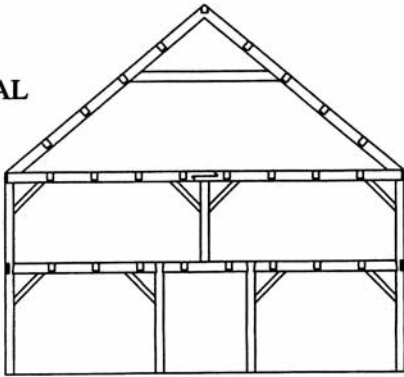

HAMMER  
BEAM  
TRUSS

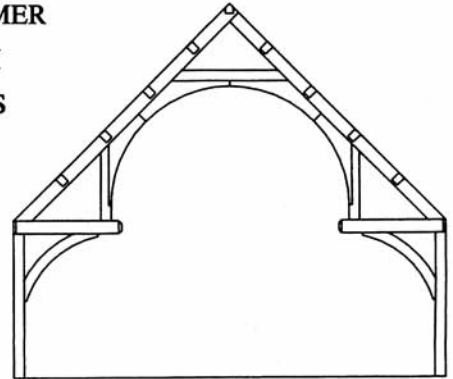

FARM HOUSE

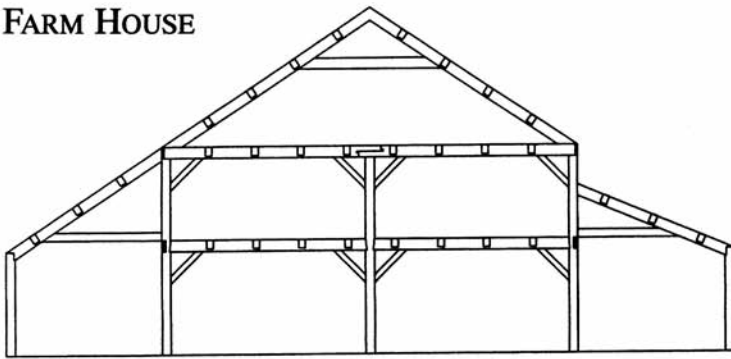

MODIFIED  
HAMMER  
BEAM TRUSS

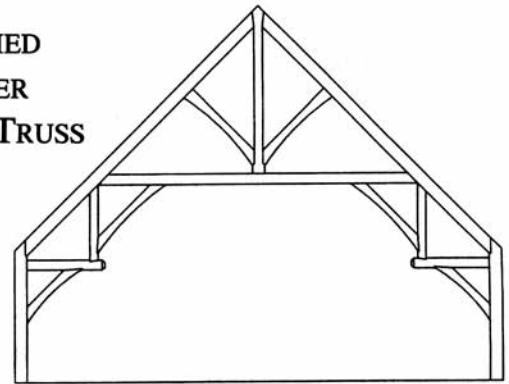

**KLONSKY RESIDENCE**

This home uses the farmhouse bent system (*see drawing above*).

# THE JOINERY

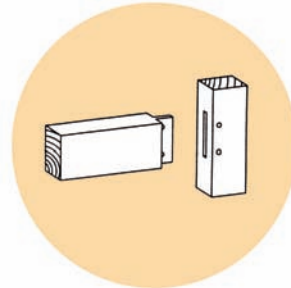

## MORTISE & TENON

As the most common timber framing joint, the mortise & tenon is versatile and functional. It is used to fasten connectors, posts, struts, etc.

## DOUBLE THROUGH MORTISE & TENON

This joint is used in cases of extreme tension. We have tested to loads in excess of 17,000 pounds tension without deforming it!

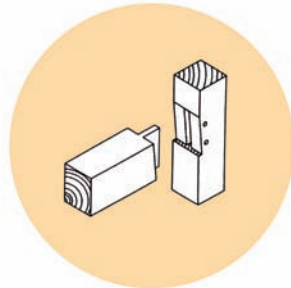
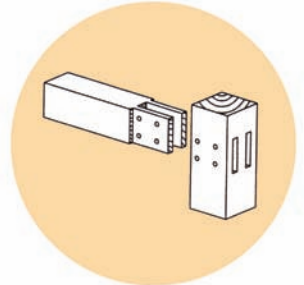

## SHOULDERED MORTISE & TENON

This joint is used to connect a girt to a post. The shoulder transfers the girts load directly to the post while hardwood pegs hold the joint tight.

## DOVETAIL

Dovetails are used to connect joists and purlins to girts and rafters. Hardwood wedges are driven into the joint to pull the joint or purlin tight.

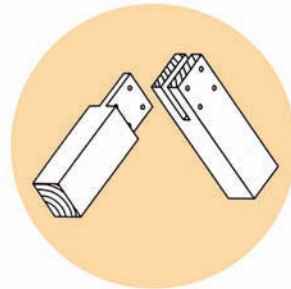
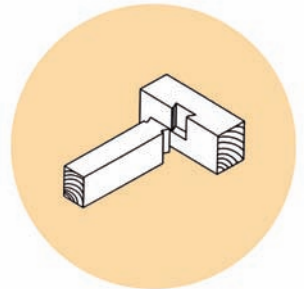

## TONGUE & FORK

Used primarily at the ridge, the Tongue & Fork locks the rafters together, and is pegged with hardwood pegs.

## STEEL JOINERY

Steel plates and bolts are often used to meet the structural and aesthetic needs of commercial construction. We can custom design gusset plates, joist hangers, and column connections reminiscent of the old fashioned mill buildings.



The key to timber framing is connecting beams together in a way which is strong and beautiful. Members should neither be too large or too small and the joints should stay tight over time. All wooden beams will shrink and check as they dry — it is part of the unique nature of timber framed buildings. Most of our joints are pinned together with 1" hardwood pegs. The geometry of the joint itself carries most of the structural load, and the peg holds the joint in place. When loads are extraordinarily large, or when aesthetics call for it, we use heavy steel plates and bolts reminiscent of old mill buildings.

# ASSEMBLY



The first step of the assembly process is putting the bents together on the deck. Multiple bents are stacked on top of each other. Then a crane lifts the bents into position. They are braced off and the purlins and connecting pieces are dropped in. Usually four to five bents can be raised in one day. The next day is spent tightening the joints, and finally stressskin panels are installed.



# TOOLS



The first step in cutting a timber frame is laying out the joints. Then the beams are predrilled for the pegs and cut to length. The mortises are punched with a “Mortising Machine”, which is a cross between a plunge router and a high tech chain saw. Pockets up to 2" deep are cut with a router. Next, the tenons and dovetails are cut with saws and chisels. We still do most of this work by hand because it is the most accurate method.



Finally the finishes are applied. Timbers get prefinished with stain, urethane, or oil. Or, for hand hewn frames, we add an antique finish with old fashioned tools for authenticity.

# THE WALL & ROOF SYSTEM

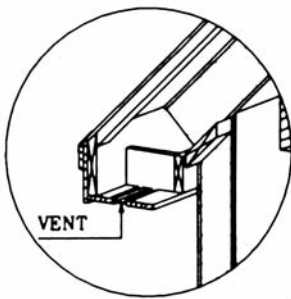

TRIM DETAIL

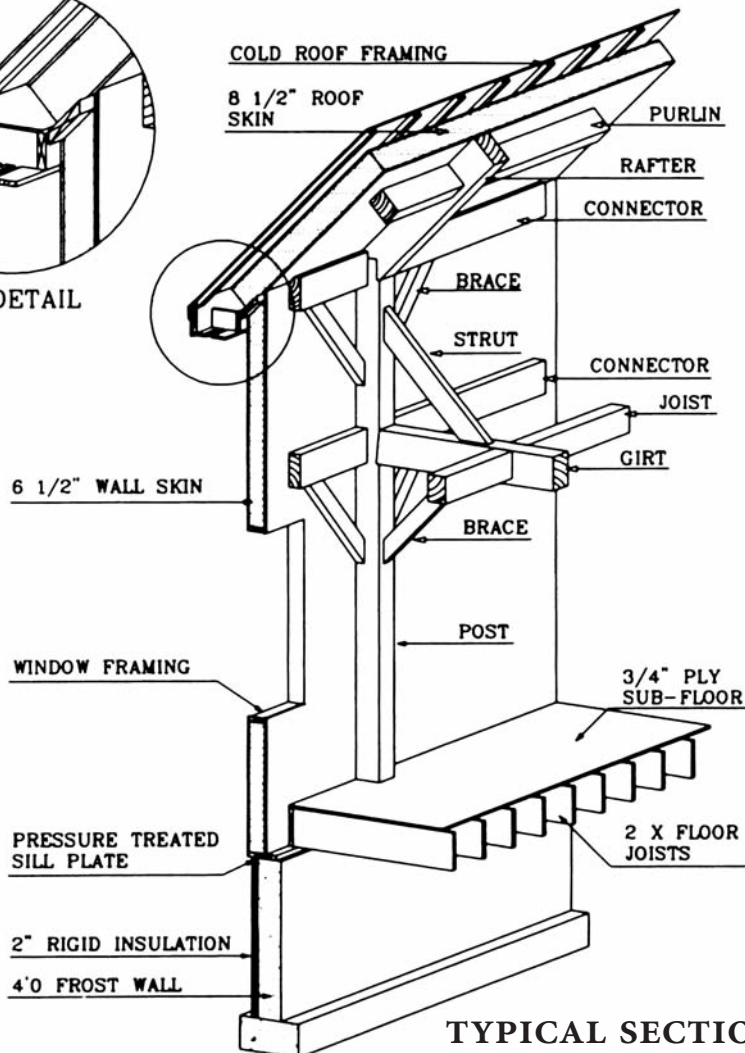

TYPICAL SECTION

## STRESSKIN INSULATING PANELS

For energy efficiency, super insulating stresskin energy panels are used to enclose many of our buildings. Stresskin is made of four layers: 1/2" Oriented strand board sheathing on the outside, expanded polystyrene foam in the middle, and 1/4" OSB backer board and 1/2" sheetrock on the inside.

## COLD ROOF

When a non-venting roofing material is used, like asphalt shingles, wood shingles or standing seam metal roofing, a vented cold roof is required to ensure that the roofing material lasts and the stresskin panels continue perform for years.

## MECHANICALS

Channels are pre-cut in the foam for electrical wires and OSB splines screwed in at the joints to hold the panels tight. 2x framing is installed around the windows and doors for added strength. Mechanicals, like plumbing and wiring can also be hidden in the 2x floor framing and the interior partitions.

## FLOORING

High quality 2x tongue and groove ponderosa pine decking is used between floors. Installing another 2x floor system above the decking for mechanicals makes sense, but pine decking is so nice that many of our clients choose to use it for their finished floors upstairs.

# COMMERCIAL PROJECTS



## THE BREED POOL HOUSE

This building is part of a 31,000 square foot estate in Vermont. It includes a 24' x 60' pool, racquetball court, spa, sauna, locker room, sun porch, steam room and conference room.

## BILLINGS FARM & MUSEUM THEATRE AND ENTRANCE

The Billings Farm & Museum is a wonderful working dairy farm and Early American museum in Woodstock, VT. We provided a rough sawn hemlock frame for their entry and beautiful douglas fir trusses for their theater.

A sampling of our commercial work is featured in this brochure. Please visit our web site at [www.vermonttimberworks.com](http://www.vermonttimberworks.com) to see a more extensive sampling. We build frames for offices, factories, pool houses, churches, state parks and hotels. We ship throughout the country, and often include assembly and erection in our scope of work. Frames are designed and engineered to meet the specific requirements of each individual project. All are unique.



## THE VERMONT TEDDY BEAR COMPANY

This frame covered 18,000 square feet with 40' x 120' clear spans, fir timbers and steel connections. It covers the factory floor, retail space and office areas. The finish is one of our favorites for douglas fir timber – UV protected spar urethane, which is beautiful and easy to clean.





#### SOUTHEASTERN VERMONT WELCOME CENTER

The Southeastern Vermont Welcome Center is on Interstate 91 North just over the Massachusetts border. It is a 48' x 96' frame in the style of old Vermont barns. The State of Vermont has done a great job setting the building up like a mini-museum, with information about the towns in the state, computer stations linked to chambers of commerce, and displays of centuries-old rural traditions. The frame is hand-hewn native white pine and oak. In keeping with architectural requirements, the joinery is traditional with wooden peg connections.

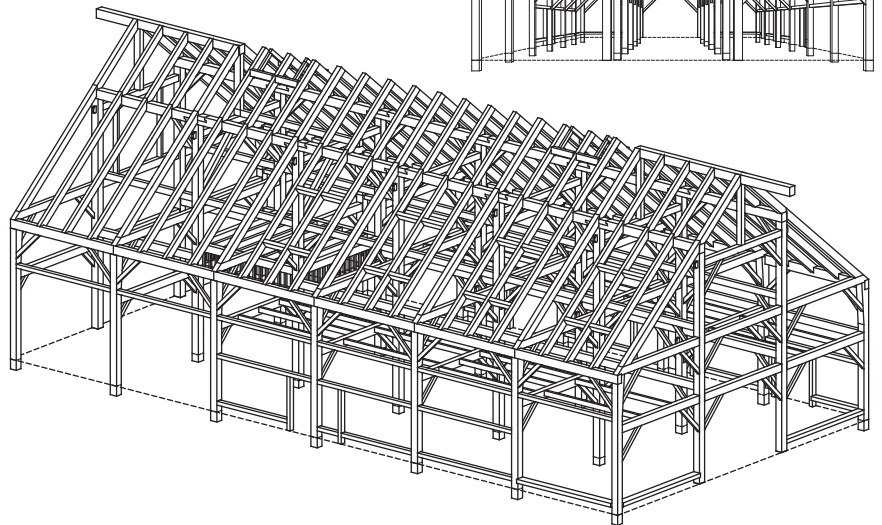
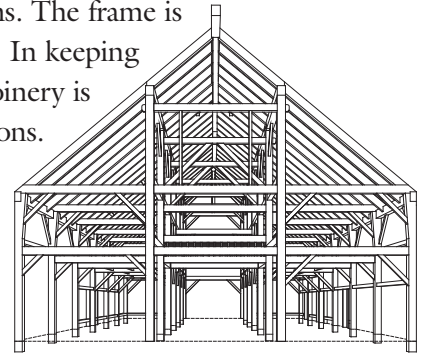

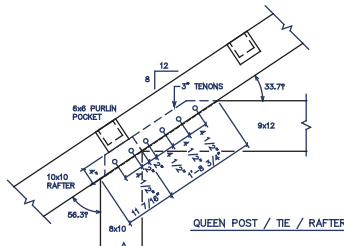

**TRAPP FAMILY LODGE**

This beautiful frame for the von Trapp Family (of “The Sound of Music” fame) is in Stowe, Vermont. Our work encompassed two parts: a complete, free standing hammer beam frame for the conference center, and beamed ceilings for the new guest rooms. The frame is made of douglas fir with natural spar urethane finish. We used hidden structural steel in the hammer beams to account for the large Vermont snow loads.

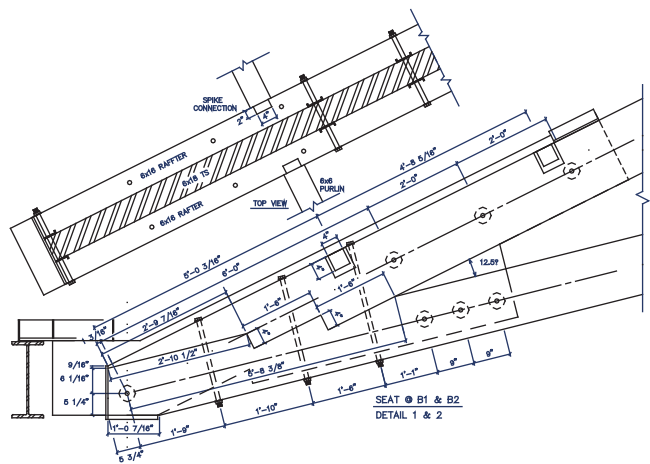
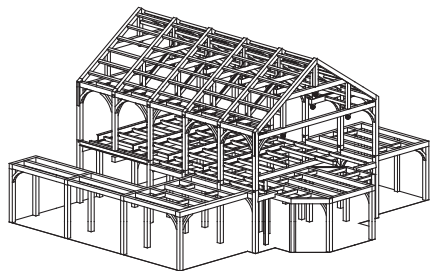

**THE EXECUTIVE CENTER**

This frame, in Armonk, NY features scissor trusses spanning over 60 feet on a 20 foot grid. They are double chorded Douglas fir 6x16's with tubular steel boots and plates at the connections. Scissor trusses are nice because of the feeling of vertical space they add to a room.

# CHURCHES & CHAPELS

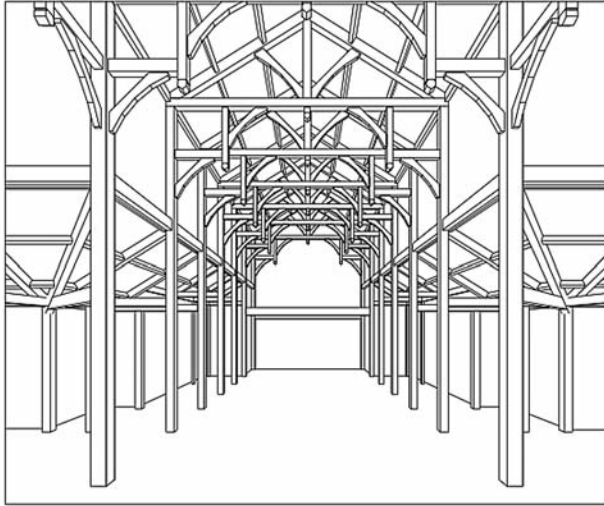

## BETHLEHEM MONASTERY

This project features a douglas fir timber frame for the sisters of the Bethlehem Monastery of Poor Clares. The 2-1/2 story frame reaches just shy of 45 feet at the top of the cupola and features graceful curved arches.

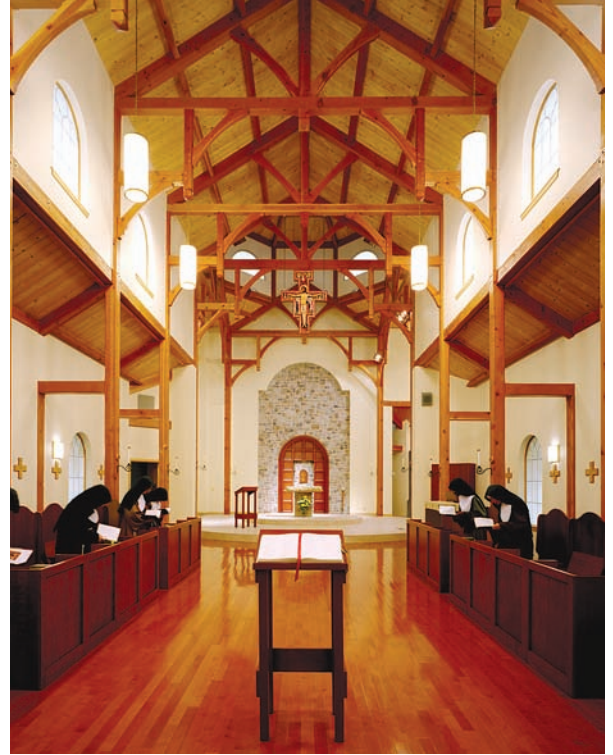

## FIRST PRESBYTERIAN CHURCH OF NAVASOTA

The First Presbyterian Church of Navasota needed custom heavy timber trusses to restore their fire-damaged church. The church, originally built in 1894, is registered as a Recorded Texas Historic Landmark. The entire roof structure was lost and rebuilt by VTW. We matched the original trusses by using douglas fir timbers. For the curved braces, glue-laminated timbers were used and wrapped with clear stock to make them appear more natural.

# BARN FRAMES



The Hermes Barn (*pictured above*) is in Shiner Texas. It was built mainly as a custom post & beam equipment barn for a small ranch, but will also be used for parties and entertainment. The barn features curved braces, a modified hammer beam design and hemlock timber.

The Brigham Hill Barn (*left*) was built for Food for the Needy, Inc. — a non-profit organization that runs the volunteer-based farm. Its annual crops are donated to hunger relief organizations throughout central Massachusetts. The frame for this barn features rough sawn native white pine with traditional joinery.



## RESIDENTIAL PROJECTS

Vermont Timber Works manufactures high quality timber frames and packages for residential homes and commercial buildings. We design, cut and assemble frames ranging from the simple and rustic to the highly finished and elegant. All of our frames are custom designed to meet the needs of each individual project. A variety of timbers are used including fir, oak and hemlock. The joinery is traditional with mortises and tenons, dovetailed joists and hardwood pegs. Our craftsmanship is meticulous, our joints are tight, and our work is guaranteed.

### **RESIDENTIAL BUILDINGS INCLUDE:**

- Custom cut hemlock, pine, oak or fir timber frame
- Choice of smooth, rough sawn, semi-smooth, or hand hewn finish
- Traditional joinery – mortise & tenon with hardwood pegs, and dovetailed joists and purlins, chamfered edges
- Stained or oiled timbers
- Assembly
- Custom frame design with blueprints
- All workmanship is fully guaranteed and insured



Above (*right*) is the interior of a restored barn which we renovated for a new owner. We worked with the client's eclectic tastes to renovate the old timber ceilings using the original owner's hand peeled poles. The Jupiter Barn interior (*at left*) built of hand hewn pine, which looks great with the stone fireplace and modern finishes.



## PRICING INFORMATION

All of our timber frames are custom priced to account for the many variables in timber framing like wood species, complexity, rough or smooth finishes, level of embellishment, curves, hips, valleys, dormers, clerestories, etc. Commercial pricing always varies depending on the structural needs of each individual project. Please call us and we will be happy to provide a free custom quote for your project.



# PROFESSIONAL ENGINEERING

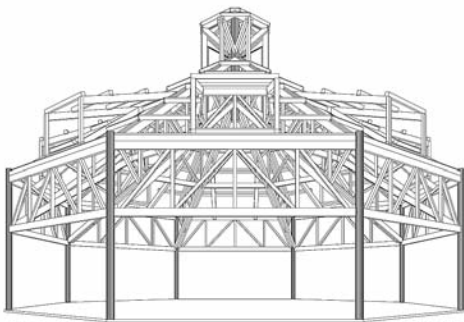

Vermont Timber Works designs and engineers complex timber frames. Our in-house professional engineer performs structural modeling and analysis on all of our frames to insure that all building code and specific structural requirements are met. Two of our projects (the cupola for the Presbyter Museum in New Orleans, and the Visitor Center at Fontainebleau State Park across Lake Pontchartrain) survived hurricane Katrina without any structural damage. Loads such as snow, wind, seismic, unbalanced loads and commercial live loads are taken into consideration. We design, engineer and build simple residential trusses spanning 24 feet as well as double corded commercial trusses that span up to 80 feet. Once a frame is engineered, we provide stamped shop drawings that include all the bent profiles, 3D renderings and joint details which are custom designed for each situation.

SPRUCE PEAK LODGE under construction (*at left*)

DOUBLETREE HOTEL LOBBY (*at top of page*)



**THE VERMONT VETERANS MEMORIAL CHAPEL**

This multi-use chapel was built in Randolph, Vermont. This lovely frame features an open air design with sliding glass walls that enclose it for winter use. It is rough sawn hemlock and pine using lateral trusses reinforced with steel rods.



36 FAIRBANKS ROAD, NO. SPRINGFIELD, VT 05150

(802) 886-1917 (FAX) 802-886-6188

[www.vermonttimberworks.com](http://www.vermonttimberworks.com)